

## SPICE thermal model

BUK9K22-80E

Symbol	Parameter	Conditions	Min	Typ	Max	Unit
$R_{th(j-mb)}$	thermal resistance from junction to mounting base		-	-	2.36	K/W

$C_{th1}$	3.575E-05 F
$C_{th2}$	1.981E-04 F
$C_{th3}$	2.706E-04 F
$C_{th4}$	1.210E-03 F
$C_{th5}$	4.930E-03 F
$C_{th6}$	5.951E-03 F
$C_{th7}$	1.357E-01 F
$C_{th8}$	6.011E+01 F
$R_{th1}$	2.533E-03 $\Omega$
$R_{th2}$	5.928E-03 $\Omega$
$R_{th3}$	3.577E-02 $\Omega$
$R_{th4}$	7.656E-02 $\Omega$
$R_{th5}$	2.422E-01 $\Omega$
$R_{th6}$	1.553E+00 $\Omega$
$R_{th7}$	4.394E-01 $\Omega$
$R_{th8}$	3.829E-03 $\Omega$

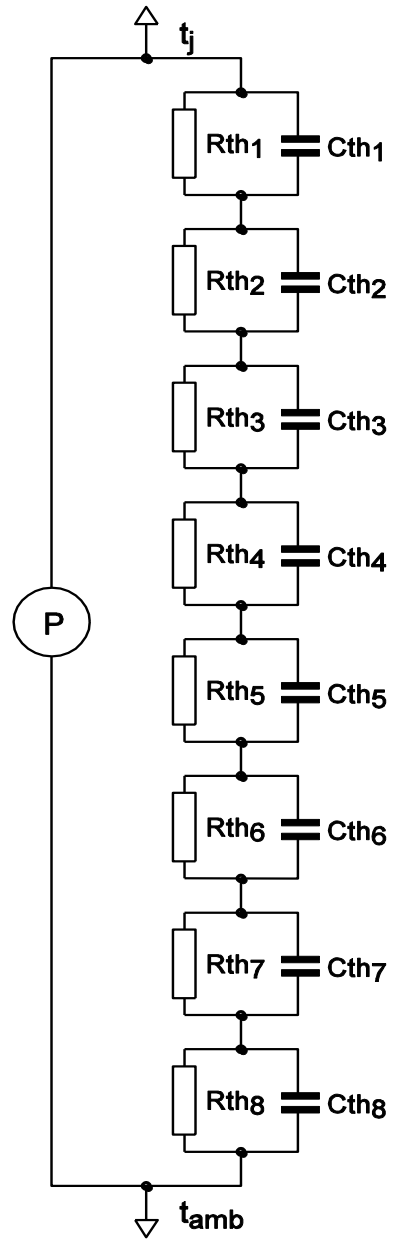

001aal768

Part: BUK9K22-80E  
 Date: 15/6/2017  
 Model Rth 2.36 K/W